

# Design of The Information System of The Quality Control on Mass Customization Production

*by Ahmad Izzuddin*

---

**Submission date:** 01-Apr-2023 10:16PM (UTC+0500)

**Submission ID:** 2052922144

**File name:** 481-Article\_Text-1672-1-10-20210722.pdf (928.86K)

**Word count:** 2765

**Character count:** 15000

## Design of The Information System of The Quality Control on Mass Customization Production

Yustina Suhandini  
Tjahjaningsih  
Panca Marga University  
Departement of Engineering  
Industrial Engineering  
Yustina.suhandini@upm.ac.id

Misdiyanto  
Panca Marga University  
Departement of Engineering  
Electrical Engineering  
Misdie@upm.ac.id

Ahmad Izzuddin  
Panca Marga University  
Departement of Engineering  
Electrical Engineering  
ahmadizzuddin@upm.ac.id

### ABSTRACT

This study aims to build a quality control model on mass customization system based on information systems that inform the quality of the product and the ability to trace the final product. The problems of mass customization systems are quite complex because the production lines often change according to customer orders. So, the quality assurance is demanded to be more precise according to the changing specifications. The possibility of claims and complaints from customers is greater than the mass production system. To minimize these problems, it is necessary to build a quality control system that utilizes an information technology system. It is to inform the quality defects that can be known quickly. The model is built by developing an initial model of quality control for mass customization production, the Defect Tracking Matrix (DTM) base on the House of Quality (HoQ). Analysis of determining product defects with the matrix model is limited because of many modul. Therefore the use of information systems is effective to overcome the weaknesses of traditional DTM systems. The model is made by the stages of the SDLC (System Development Life Cycle), namely: planning, analysis, design, implementation, maintenance. Based on the analysis, the model is implemented to the Plywood Industry, especially Particle board Division.

**Keywords :** Defect Tracking Matrix (DTM), SDLC, mass customization, quality control

### 1. INTRODUCTION

Every company maintains product quality for sustainability. One of the keys to the company's success is meeting customer needs as required. Customer satisfaction is a quality standard that must be fulfilled, while customer demand for products is increasingly individual, causing considerable product variation. The market opportunity that must be captured is the production of mass customization (MC) products to meet personal consumer needs that previously could not be fulfilled for product types with standardized variations in mass production (MP). According to Pollar & State [1] there are four advantages of applying MC and four approaches to applying MC. The production system with the MC model provides a more complex quality control system challenge because of the high variety of products and the requirements that must be met for MC implementation. Tseng et al. [2] describes the requirements that must be met, namely: time to market, variety, economy of scale and Silveira et al. [3] stated that in practice the company is sufficient to meet certain abilities at the MC level because in practice not all companies are able to meet the requirements required in the implementation of MC.

The lack of literature on quality control in MC systems encourages Wang & Lin [4], [5] to develop a DTM (defect tracking matrix) method based on house of quality for quality control in the MC production process. The application of the DTM method for quality control has also been used to control the quality of the MP system in the furniture industry in Indonesia [6]. The weakness of the DTM method when implemented in the MC Industry is that if a product consists of many specific module it will create a large enough reconfiguration DTM matrix so that manual DTM creation is ineffective. Therefore, the use of information technology is needed to perfect the DTM system concept so that it can be implemented for quality control. The SDLC (System Development Life Cycle) procedure was chosen for designing a web-based information system that has the advantage of being accessible by users using a web browser found in all desktop and smartphone computer operating systems. [7]

### 2. LITERATURE REVIEW

#### 2.1 Mass Customization

MC is the company's ability to produce goods or services according to the desires of consumers but with production efficiency such as mass producing goods or services [8]. MC is also a company's ability to produce a large variety of products and with a short lead time. This principle then allows the company to be able to seize new market opportunities as well as consumer needs that previously could not be fulfilled by products that generally have standardized variations. In this case, it should be emphasized that the term customization in MC does not only mean "customization" products, but mass customization of products. With an efficient production process like mass production (MP), but with a large variety of products and allowing consumers to choose the design they want, the characteristics of MC's business processes are different from MP.

The method to achieve mass customization as below :

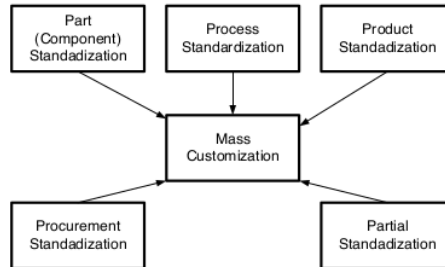

**Figure 1. The method to achieve mass customization**

This figure illustrates the dominant operational method and facilitates the concept of mass customization in the practice. There are four approaches to standardization, the part standardization, standardization of process, standardization of product, and standardization of procurement [9].

## 2.2 Defect Tracking Matrix base on House of Quality

DTM is a new tool for quality control in mass customization production. DTM has introduced by Hua Wang & Zhongqin Lin at 2007 [4] for problem solving a case study in a manufacturing industries. A case study proves the usefulness of DTM. The lack of literature on quality control in mass customization (MC) systems prompted Wang & Lin to develop a quality control tool in the form of a matrix, called defect tracking matrix (DTM) based on House of Quality (HoQ) for tracking defects in the MC production process. DTM links manufacturing techniques with quality defects directly. This makes it possible to find the cause of quality defects quickly. There were five steps to construct a DTM as below :

1. Representing the modular manufacturing with the techniques attributes ( $TA_s$ )
2. Determining the quality defects ( $QD_s$ )
3. Constructing the relationship matrix, R
4. Determining the weights of  $TA_s$  and  $QD_s$  using AHP.
5. Deduction of the correlation matrix, S

In previous research, DTM has been proven to be used for quality control in Mass Customization Production (MCP), but the matrix system has a weakness if the product consists of many specific modules, so the matrix must be large enough, therefore the Information technology to build information system applications is needed to solve the problem.

## 2.3 Systems Development Life Cycle (SDLC)

SDLC is a method for system development that functions as a mechanism to identify software [10]. The systems life cycle is a methodology, but the pattern is more influenced by the need for faster system development which is achieved by increasing the life cycle and using computer-based development tools. The design of the quality control information system application is a system design built for quality assurance based on the flow of the production process from upstream to downstream. The information system application is designed to expedite the quality control process on the MC system with the system development life cycle method which consists of five stages with the following steps [11]: system planning, system analysis, system design, system implementation, and system maintenance.

## 3. METHODOLOGY

The research was begun with collect the data from the company for fulfill the procedures of DTM. The data is the product process flow has observed. The data obtained were used to perform DTM analysis. To construct of DTM, the first step is determine the types of techniques attributes ( $TA_s$ ) which representing the modular manufacturing process and determining the quality defects ( $QD_s$ ), then construction the relationship matrix, R between ( $TA_s$ ) and ( $QD_s$ ). Determining the weights of  $TA_s$  and  $QD_s$  using AHP. The AHP by Saaty is useful for acquiring feature weights and relationship coefficients from domain experts. Then the next procedure is deduction of the correlation matrix, S as below :

$$S_{xy} = \sum_{i=1}^m [R_{ix} \cdot w(TAi) \cdot (R_{iy} \cdot w(TAi))] \\ = \sum_{i=1}^m R_{ix} \cdot R_{iy} \cdot w^2(TAi), \quad x, y = 1, 2, \dots, n, x \neq y \quad S = [S_{xy}]$$

The next step is to build an information system from the DTM integration model following the SDLC procedure. The application software has made then were tested in case studies at one of manufacturing industries in Probolinggo.

### 3.1 System Planning

The activities carried out are defining the problems and the goals. The problem is how to built information system for quality control in the mass customization system with the DTM method. The purpose of the new system is to develop an information system based on the DTM model.

### 3.2 System Analysis

Its begin with analyzing the existing quality control system for determining product defects, so the information of the DTM system that has built in the company could known. The results of this analysis are used to design a new information system.

### 3.3 System Design

At the design stage, the activities carried out are modeling the DTM process, making use case diagrams, Entity Relationship Diagrams (ERD), creating data models, and creating interface displays.

### 3.4 System Implementation

Based on the existing design, a quality control application system with the DTM model has made and implemented in the manufacturing industries.

### 3.5 System Maintenance

The application system that has been implemented continues to be evaluated and modified so that the system always provides support and optimizes the quality control system.

## 4. Case Study

### 4.1 System Planning.

PT. Kutai Timber Indonesia (KTI) is a Joint Venture company between Fa. Kaltimex Jaya (Kal-Tim) with Sumitomo Forestry Co. Ltd. Tokyo Japan. PT. Kutai Timber Indonesia basically produces plywood, but with the increasing demand, it does not only produce plywood but also produces various goods such as Wood Working, Secondary Processing and Particle Board. The production system on Particle Board starts with Log Yard, Chipper, Chip Silo, Flaker, Wet Silo, Dryer, Screening, Forming, Pre Press, Hot Press, Cooling, Cut to Size, Sanding, Ware House, and finally Deliver to the customer. Determination of defects in the quality control process with mass customization products is carried out using the DTM method. The application of the DTM method in tracking defects has experienced problems because the quality control process consists of many modules, so the matrix on the DTM is long to be described manually, thus requiring the design of an information system to complete it. Therefore, the purpose of designing this system is to create a quality control application system for tracking of defect with DTM's steps using the SDLC method.

### 4.2. System Analysis

The overall of quality control system in the Particle Board Division of PT KTI is related to three units, namely: quality control unit, production unit and maintenance unit. Determination of product defects are mostly done by the Quality Control Section. Defect tracking starts from the cut to size machine, by the quality control section. They are looking visually when the product cutting process. The types of quality measured are include: dimensions, length, and width. During the inspection, if a defect of product is found, then it is decided by the quality control department that the product is rejected or downgraded to C quality. Likewise for quality checks on the Sanding machine. In the sanding area, manual checks are carried out during the sanding process for each board that is taking place. Visual checks are carried out one by one and if a defect is found in the product, it will be sorted out whether it is grade C or rejected. Summary of the product quality, down grade, or defect are do by manual ways. The inspection procedure takes a long time to find out the type of defect that has occurs every day.

To find the cause of the defect, Its require cooperation between the production, quality control and maintenance departments. If the Production Department or Quality Control Section finds that the cause of the defect is due to engine damage, the production section will make a request for repairs to maintenance and the maintenance section based on the report will check and repair. When checking the cause of engine damage or the cause of the defect, it will take a long time before a corrective action is decided. Production that is mass customization will change

production process models more often, this will risk the types of defects that will vary, according to the frequent changes in the production process that occur. The existing system will take time to find out the types of defects and their causes. Therefore, designing a quality control information system to determine defects and their causes are one solution to solving quality control problems in mass customization production systems. Defect Tracking Matrix is a quality control model, that its used for mass customization production and has been used for quality control in several industries.

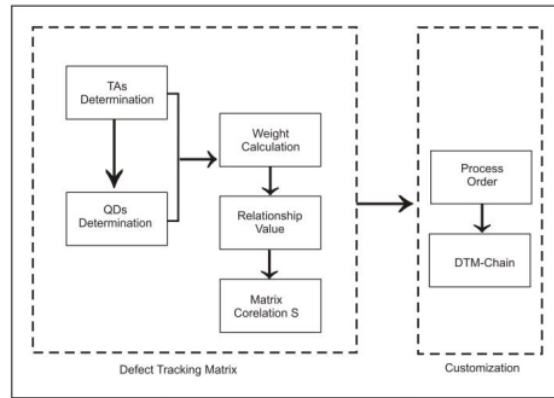

Figure 2. DTM initial system analysis

### 4.3. System Design

#### 4.3.1 The type of Server

The minimum recommended server computer requirements for operating the DTM application system are as follows: It has a Processor comparable to Intel Pentium IV (1.8 GHz), if you use a Mikrotik operating system, it has a minimum speed (2.4 GHz), while if you use Debian / Ubuntu Server. Memory capacity of at least 512 MB. 40 GB hard drive. Its an Ethernet (NIC / LAN Card) 2 ports.

3

#### 4.3.2 Use case Diagram

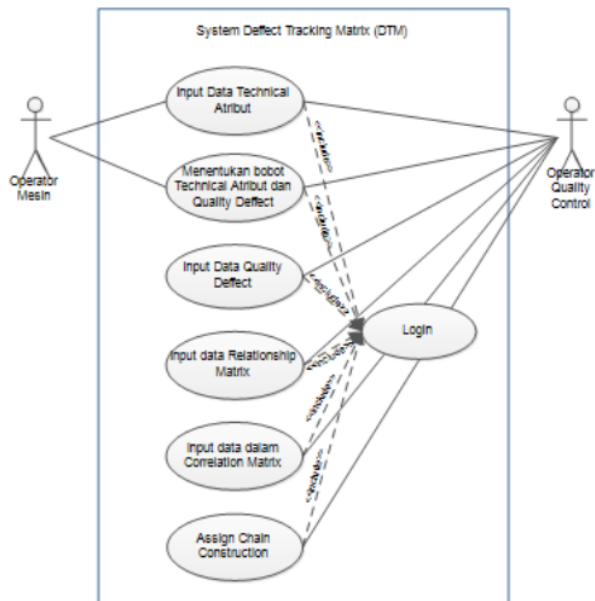

Figure 3 Design of use case diagram

4.3.3 Entity Relationship Diagram

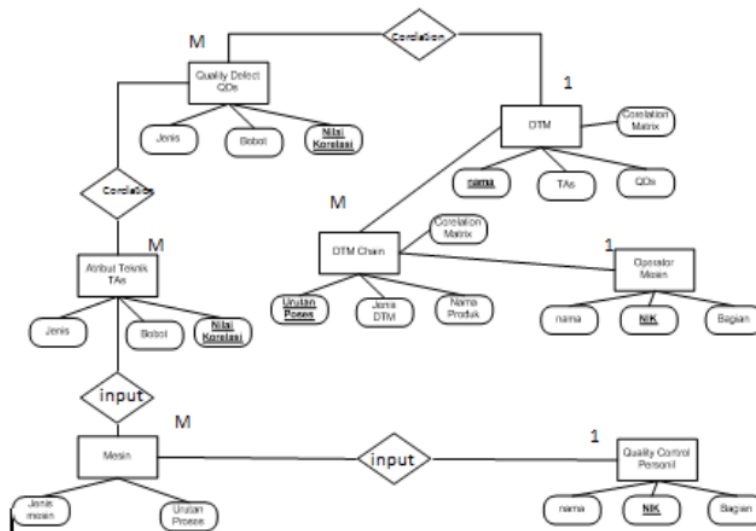
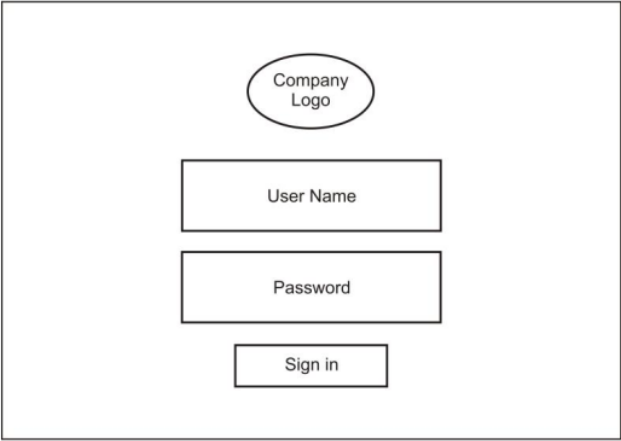

Figure 4. Design of ERD

The system display design is as follows:  
 a. Design of Login page display :



**Figure 5.. Display of login page**

b. Display of DTM design

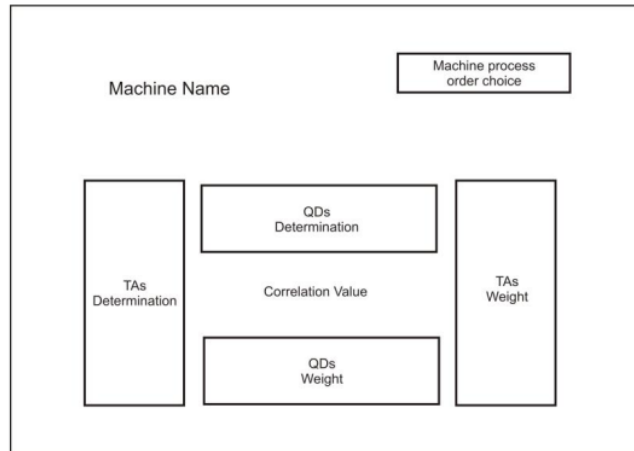

Figure 6. Display of DTM design

c. Display of DTM-chain design

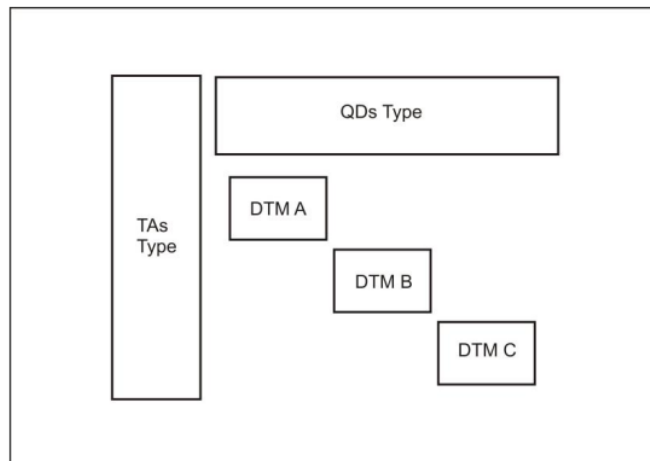

Figure 7. Display of DTM-chain design

**4.4. System Implementation**

From the display design that has been made, the implementation of the DTM application is carried out to detect the defects that occur in the mass customization production system while simultaneously testing the data obtained from the Particle Board Division as follows:



a. Interface page :

Figure 8. Interface page

b. DTM for Forming Machine

| Forming Machine Technical Attribute (TA) | QD1 (Dust Spot) | QD2 (Rough Surface) | QD3 (Core Showing) |
|--|-----------------|---------------------|--------------------|
| TA1 (Dust Content)                       | -9              | -3                  | 0                  |
| TA2 (Cleaning Ducting)                   | -9              | -3                  | -3                 |
| TA3 (Setting Section)                    | -3              | -3                  | -9                 |
| TA4 (Setting Blower Cleaning Screen)     | -9              | -3                  | -3                 |
| TA5 (Forming)                            | -3              | -9                  | 0                  |

Figure 9. Result of entry : Relationship matrix Forming Machine(1)

| Forming Machine Technical Attribute (TA) | QD1 (Dust Spot) | QD2 (Rough Surface) | QD3 (Core Showing) |
|--|-----------------|---------------------|--------------------|
| TA1 (Dust Content)                       | -9              | -3                  | 0                  |
| TA2 (Cleaning Ducting)                   | -9              | -3                  | -3                 |
| TA3 (Setting Section)                    | -3              | -3                  | -9                 |
| TA4 (Setting Blower Cleaning Screen)     | -9              | -3                  | -3                 |
| TA5 (Forming)                            | -3              | -9                  | 0                  |

Figure 10. Result of entry for : Relationship matrix Forming Machine (2)

d. DTM for Hot Press

| Hot Press Technical Attribute (TA) | Quality Defect     |                 |             |                  |               |
|------------------------------------|--------------------|-----------------|-------------|------------------|---------------|
|                                    | QD4 (Less Sanding) | QD5 (Thin Spot) | QD6 (Crack) | QD7 (Oil Stains) | QD8 (Blister) |
| TA6 (Simming Press)                | -9                 | 0               | 0           | 0                | 0             |
| TA7 (Calibration Press)            | -3                 | 0               | -3          | 0                | -3            |
| TA8 (Input Transduser)             | -9                 | 0               | 0           | 0                | 0             |
| TA9 (Hammering)                    | -1                 | -9              | 0           | 0                | 0             |
| TA10 (Cleaning Protection)         | -3                 | -9              | 0           | 0                | 0             |
| TA11 (Change Seal)                 | 0                  | 0               | 0           | -9               | -1            |

Figure 11. Result of entry for : Relationship matrix HOT PRESS

e. Cut to Size

| Cut to Size Technical Attribute (TA) | Quality Defect      |                 |               |              |
|--------------------------------------|---------------------|-----------------|---------------|--------------|
|                                      | QD9 (Rough Cutting) | QD10 (Diagonal) | QD11 (Length) | QD12 (Width) |
| TA12 (Circle Knife)                  | -9                  | -3              | -3            | -3           |
| TA13 (Setting Pusher)                | 0                   | -9              | -3            | -3           |
| TA14 (Setting Blade Position)        | 0                   | -3              | -9            | -9           |

Figure 12. Result of entry for : Relationship matrix CUT TO Size

f. DTM for Sanding Machine:

| Sanding Technical Attribute (TA)           | Quality Defect     |              |                        |                     |
|--|--------------------|--------------|------------------------|---------------------|
|  | QD13 (Cutter Mark) | QD14 (Tirus) | QD15 (Sloping Sanding) | QD16 (Paper Stripe) |
| TA15 (Sand Paper Change)                   | -9                 | -3           | 0                      | -9                  |
| TA16 (Platten Change Seeting Rubber input) | 0                  | -9           | -3                     | 0                   |
| TA17 (Stacker)                             | 0                  | 0            | -9                     | 0                   |
| TA18 (Sensor Tracking)                     | -3                 | -1           | -1                     | -9                  |

Figure 13. Result of entry for : Relationship matrix Sanding Machine.

From the DTM made, based on the incoming particle board product order, a DTM-Chain is made according to the requested process, namely: Forming Machine-Hot Press-Cut to Size-Sanding Machine.

g. DTM-Chain

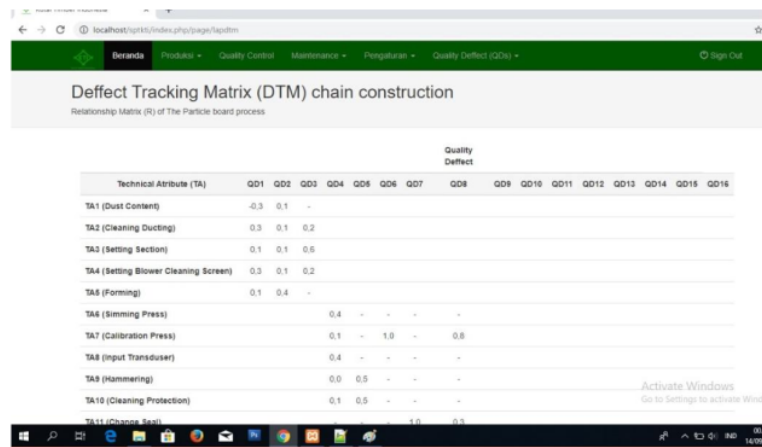

Figure 14. DTM Chain Construction

#### 4.5. System Maintenance

The system that has been created, although a test of case studies in the particle board division has been carried out, still needs continuous improvement to adjust to the changes that occur. Modifications are still needed to improve the quality control system in mass customization production. The changes in the sequence of processes and the development of defects need to be added to the database so that the application system is more flexible in its use

#### 5. CONCLUSIONS

After analyzing, the design of a quality control information system on the mass customization production system using the DTM method, it was concluded that the information system design that was made after being implemented in the Particle Board Division could speed up defect tracking and make it easier for the Quality Control section to control defects in its department.

#### 6. REFERENCES

- [1] Pollard, D., State, C.(2008), "Strategies For Mass Customization," *Journal of Business*, vol. 6, pp. 77-86.
- [2]Tseng, M., Jiao, R., & Wang, C. (2010), "Design for Mass Personalization", *Journal of Manufacturing Technology*, vol.59, 175-178
- [3]Silveira, G., Borenstein, D., Fogliatto, F. (2001), "Mass customization: Literature review and research direction", *International journal production economics*, vol. 72; 1-13.
- [4]Wang, H., Ling, Z. (2008), "Defect tracking matrix for mass customization production based on quality", *International journal flexibility manufacturing system*, vol. 19; 666-684.
- [5]Hua Wang (2013), "Defect tracking in mass customization using defects tracking matrix combined with principal component analysis", *International journal of Production Research*, vol. 51 No. 6 ; 1852-1868.
- [6]Tjahjaningih, Yustina Suhandini., dkk. 2012. *Pengembangan Model Pengendalian Kualitas pada sistem mass customization dengan mengintegrasikan QFD,DTM*. Prosiding Simposium Nasional RAPI XI FT UMS - 2012 ISSN : 1412-9612, I-133 s/d I-140.
- [7] Hermawan, Rudi; Arief Hidayat, Victor Gayuh Utomo, 2016. " Sistem Informasi Penjadwalan Kegiatan Belajar Mengajar Berbasis Web" *Indonesian Journal on Software Engineering*, vol. 2. no. 1 , ISSN 2461-0690.
- [8] Pine, B.J. II. (1993a), "Mass customizing product and services", *Plann Rev* 21(4): 6 – 14.
- [9]Selladurai, R.S. (2004), "Mass customization in operation management: oximoron or reality". *International Journal Management Science*, vol. 32; 295-300.
- [10] Ladjamudin bin, Al Bahra, 2009. *Analisis dan Desain Sistem Informasi*, Yogyakarta: Graha Ilmu.
- [11] Supriyanto, Aji.2010. *Pengantar Teknologi Informasi*, Jakarta: Salemba Infotek.

# Design of The Information System of The Quality Control on Mass Customization Production

## ORIGINALITY REPORT

8%

SIMILARITY INDEX

4%

INTERNET SOURCES

4%

PUBLICATIONS

0%

STUDENT PAPERS

## PRIMARY SOURCES

|   |   |     |
|---|---|-----|
| 1 | Hua Wang. "Defects tracking in mass customisation production using defects tracking matrix combined with principal component analysis", International Journal of Production Research, 2013<br>Publication | 4%  |
| 2 | <a href="http://repository.unmuhjember.ac.id">repository.unmuhjember.ac.id</a><br>Internet Source   | 1%  |
| 3 | <a href="http://www.researchgate.net">www.researchgate.net</a><br>Internet Source   | 1%  |
| 4 | <a href="http://www.coursehero.com">www.coursehero.com</a><br>Internet Source   | <1% |
| 5 | <a href="http://ejournal.bsi.ac.id">ejournal.bsi.ac.id</a><br>Internet Source   | <1% |
| 6 | <a href="http://www.neliti.com">www.neliti.com</a><br>Internet Source   | <1% |
| 7 | <a href="http://journal.unilak.ac.id">journal.unilak.ac.id</a><br>Internet Source   | <1% |

8

[ejurnal.universitaskarimun.ac.id](http://ejurnal.universitaskarimun.ac.id)

Internet Source

<1 %

9

[repository.umy.ac.id](http://repository.umy.ac.id)

Internet Source

<1 %

10

[www.ijirset.com](http://www.ijirset.com)

Internet Source

<1 %

11

[www.termpaperwarehouse.com](http://www.termpaperwarehouse.com)

Internet Source

<1 %

Exclude quotes On

Exclude matches Off

Exclude bibliography On